

O LIGHT

User Manual

CE 0123 EN 362:2004/M

O LIGHT

Connector

Subject to technical changes

BRIEF DESCRIPTION

INTENDED USE

The connector O LIGHT is part of personal protective equipment (PPE) of category III to prevent falls from heights. The O LIGHT serves to connect several parts of a securing system. The upper and lower part of the O LIGHT are connected to each other with screws. The special design allows loads up to 20 kN despite the divisibility of the connector.

Application temperature: -20 °C to +60 °C

All other uses are deemed improper. The company BORNACK will not be liable for any ensuing damages. The user bears the sole risk.

EQUIPMENT

- Ring-shaped connector made of aluminium with a red upper part and black lower part
- Fastener opening width: 22 mm
- Inner diameter: 38 mm
- Outer diameter: 70 mm
- Diameter of the cross-section: 16 mm
- 2 stainless steel screws with O rings made of rubber to ensure that the screws fit tight
- Allen wrench SW 3 mm

USE

- Connection of several parts of a securing system

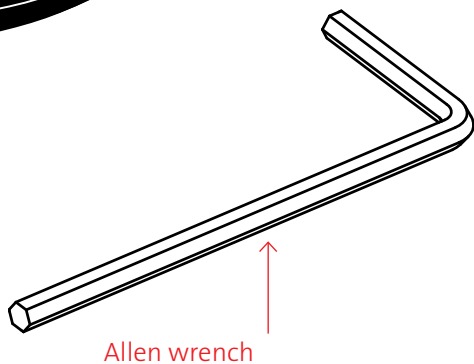
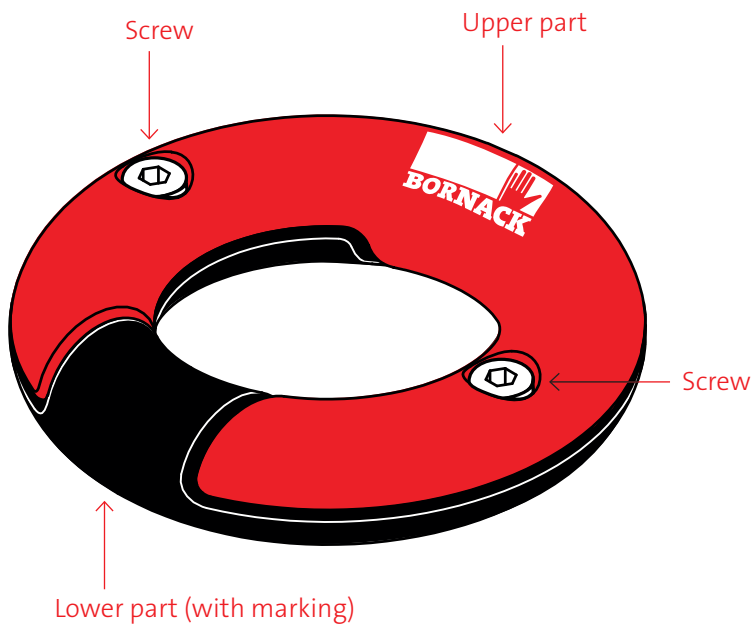
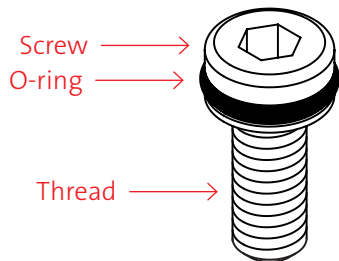

INFORMATION BEFORE USE



Always check before use!

- The personal protective equipment (PPE) may no longer be used even in the case of very minor faults.
- Faulty PPE components may only be tested or repaired by BORNACK or in a workshop authorised in writing by BORNACK.
- Regular inspections are essential because the safety of the user depends on the efficiency and durability of the PPE.
- The user must have completely read and understood the User Manual before use.

VISUAL INSPECTION

- No deformations, cracks, grooves, notches, wear or other damage.
- No soiling of the connector.
- O-rings are on the screws and are undamaged.
- The last inspection by an expert was carried out within the past 12 months.

FUNCTION TEST

- Screws can be turned in and out easily.

O LIGHT IN USE

OPEN AND CLOSE THE CONNECTOR ELEMENT

A Unscrew the two screws in an anticlockwise direction using an Allen key.

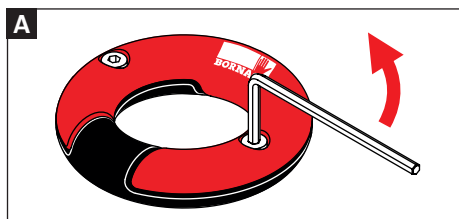

B Dismantle the upper and lower part of the O LIGHT.

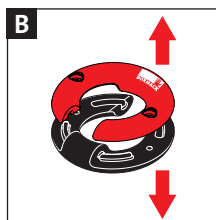

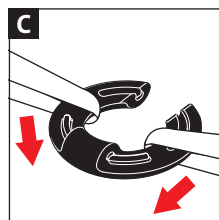

C Slip the parts of the securing system that need to be connected over the lower part.

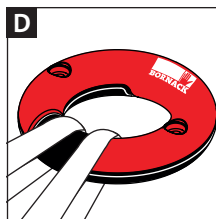

D Assembly of the upper and lower part.



CAUTION THREAT TO LIFE:  Always check that there are no objects between the upper and lower part!

CAUTION THREAT TO LIFE:  If parts of the securing system cannot be used in a way that allows the upper and lower part of the O LIGHT to be assembled correctly, the O LIGHT may not be used to connect these parts!

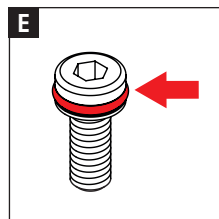

E Ensure that the O-rings are positioned correctly on the screws.

O LIGHT IN USE

F Screw in both screws using the Allen key in a clockwise direction and tighten up to 2.0 Nm.

CAUTION THREAT TO LIFE:



Only a connector that is assembled correctly is able to withstand the stated loads! Therefore, always carry out a visual inspection and test the function every time before use!

Check:

Do the screws sit tightly?
Are the screw heads lowered into the upper part and do they not protrude?
The upper and lower part of the O LIGHT sit tightly on each other and cannot be taken apart or pushed against each other?

CAUTION:



Even if the connector has been closed for a longer period, the tightening torque should be checked at regular intervals.

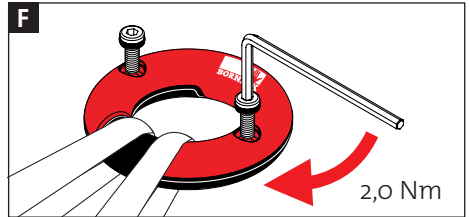

O LIGHT IN USE

LOAD DIRECTIONS

G Only use the connector so that it can be aligned optimally in the load direction.

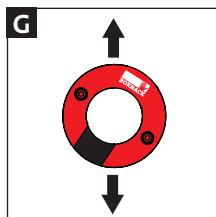

CAUTION THREAT TO LIFE:



The connector has the stated load-bearing capacity of 20 kN in the longitudinal direction (when assembled correctly)! Other types of force application can reduce the load-bearing capacity and should therefore be excluded!

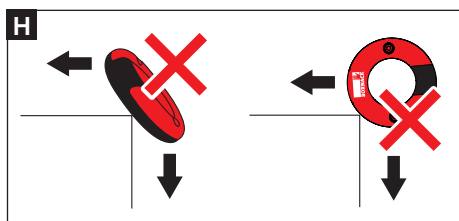

H Do not load connector element over edges.

CAUTION:



Using the connector with wide straps can reduce the strength of the connector.

O LIGHT IN USE

ANCHOR POINTS

CAUTION THREAT TO LIFE: 
Attachment points must be adequately strong (observe EN 795)!

CAUTION THREAT TO LIFE: 
When selecting the anchor point, minimise the fall height and/or the free fall!

USE IN ARRESTING SYSTEMS

I If the connector is used in an arresting system, only a full body harness that complies to EN 361 may be used.

Observe the User Manual of the full body harness.

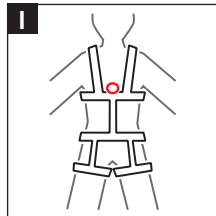

CAUTION: 
The length of the connector needs to be taken into account when used in an arresting system because this impacts on the fall path.

SAFETY INSTRUCTIONS

There is a risk to life if these safety instructions are not observed!

- The personal protective equipment (PPE) may no longer be used even in the case of very minor faults.
- Damaged, fall-stressed, dubious personal protective equipment or safety devices must be immediately withdrawn and not used. The equipment may only be inspected by an expert in compliance with DGUV principle 312-906, by BORNACK or by a workshop authorised in writing by BORNACK. This must be documented in the test card.
- Independent modifications or repairs are not allowed.
- Rope protection is part of the personal fall prevention equipment and should be assigned to a specific person.
- The personal protective equipment may only be used by qualified staff that are familiar with the material. They must be proficient in handling the personal protective equipment and must have been briefed about the possible risks associated with its use.
- In accordance with the accident prevention guidelines (UVV), the users of fall protective equipment (Category III) must attend a theoretical training course and a practical training course. To this end, profit from the training competence of the BORNACK training centres info@bornack.de
- Accessories from other manufacturers may only be used if approved by BORNACK and may not impair the function and safety of the protective equipment.
- Clothing and shoes must be suitable for the task at hand and the weather conditions.
- Only use if fully fit and healthy. Health impairments can jeopardise the safety of the user when working at heights or depths.
- If this PPE is used as an arresting system (free fall is possible), only full body harnesses that comply with EN 361 may be used.
- Calculation of the possible fall path, if all necessary PPE components are used correctly: (if necessary braking path HSG) + surplus connector (situation-dependent) + braking path energy absorber (max. 1.75 m) + height of D-ring (1.5 m) + safety reserve 1.0 m.
- Before using, ensure adequate clearance below the user to prevent impact on a protruding object or the ground.

SAFETY INSTRUCTIONS

- Protect PPE during storing, use and transportation against the effects of heat (e.g. welding flames or sparks, burning cigarettes) and chemicals (e.g. acids, alkalis, oils) and mechanical impact (e.g. sharp edges).
- The combinability and protective effect of the PPE must be checked for each hazard situation (risk assessment).
- If a casualty hangs motionless in a full body harness for a longer time, blood cannot flow back from the legs and/or the flow may be interrupted. This can lead to a suspension trauma, a circulatory shock with serious to fatal consequences.
- Before starting work, the responsible person must draw up a plan of rescue measures that defines how to rescue casualties quickly and safely and ensures first aid measures. Casualties must be rescued within 20 minutes. BORNACK can help you draw up tailor-made rescue plans and includes these in the necessary training courses. E-Mail Hotline: info@bornack.de
- The local safety guidelines (e.g. in Germany, the DGUV Regulations 112-198 and 112-199 issued by the professional associations) and the accident prevention guidelines for the specific industry (UVV) must be observed.
- Connectors with manual locking fasteners should only be used if the user does not hook it in and out very frequently, e.g. several times during a work day.

OTHER

APPROVAL

Complies with the Directive (EU) 2016/425 for PPE.

Type testing and production monitoring by:

TÜV Süd, Product Service GmbH
Daimlerstr. 11, D-85748 Garching
CE 0123

Quality management system certified to
DIN EN ISO 9001:2015.

Production monitoring by notified office
in accordance with Category III.

REGULAR INSPECTIONS

- This personal protective equipment must be inspected at least once a year by an expert in compliance with DGUV Principle 312-906. The result must be documented in the test card at the end of this User Manual.

SALES

- The dealer must ensure that the User Manual is supplied in the language of the designated country. The respective translation must be authorised by BORNACK.

SERVICE

If you have any further questions about this PPE or other BORNACK services, such as:

- Risk analysis
- Rescue plans
- Training courses
- Expert inspections
- Technical inspections
- Maintenance + inspections

please send your question to our e-mail
hotline Hotline: info@bornack.de

We will be happy to help!

OTHER

MAINTENANCE

- If necessary, use small quantities of silicon oil to protect the thread against soiling. Mineral oils may not be used on the O LIGHT because the O-rings of the screws could become corroded. Ensure that the oil does not come into contact with textile PPE components.
- Maintenance may only be carried out by a qualified expert in compliance with DGUV Principle 312-906. All instructions in this user manual must be strictly observed.
- Protective equipment that is clean and well looked after will last longer!

CLEANING

- Dry damp personal protective equipment in the air, not on artificial heat sources. Dry metal components with cloths.
- If disinfection is necessary, please contact the e-mail hotline: info@bornack.de
- If the personal protective equipment comes into contact with saltwater, keep it wet until it can be rinsed with plenty of distilled water.
- Use compressed air to blow on the unit if necessary.

LIFE SPAN

Metal parts are not subject to age-related life span deadlines. The expert makes a decision about these parts based on his technical expertise.

For reasons of safety, intensive use and/or extreme application conditions such as sharp edges, chemical influences etc. will reduce the usage period. The company owner needs to take this into account in the workplace risk analysis.

The test card at the end of this user manual must be presented during the regular expert inspections and be completed by an expert.

For more details, please visit is available online at www.bornack.de.

REPAIRS

- For reasons of liability, repairs may only be carried out by BORNACK or in a workshop authorised in writing by BORNACK.
- Only original spare parts from the manufacturer may be used.

OTHER

STORAGE

- Dry damp PPE **before** storage.
- Store in a dry place away from direct sunlight.
- Do not store PPE near radiators. Permanent exposure to temperatures or more than +50 °C has a negative impact on the strength of the materials and shorten the life span.
- Do not allow PPE to come into contact with aggressive substances (e.g. oils, grease, acids, chemicals).
- Do not store PPE close to aggressive substances (see above) because even the vapours of aggressive substances can have a negative effect on the strength of the PPE. Small quantities of silicone oil may be applied to the thread of the O LIGHT. Always ensure that textile PPE components do not come into contact with the oil.
- Protected storage in the device case or device bag.

TRANSPORT

- Protected transport in the device case or device bag.

OTHER

PRODUCT IDENTIFICATION

The following identification is on the product:

Upper part:

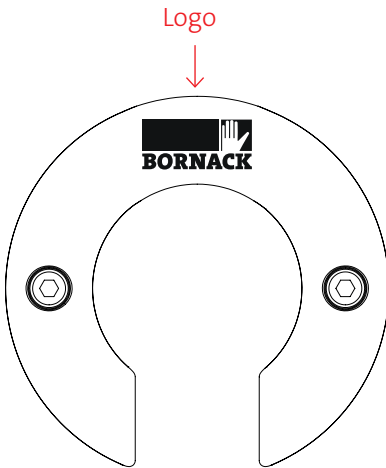

Lower part:

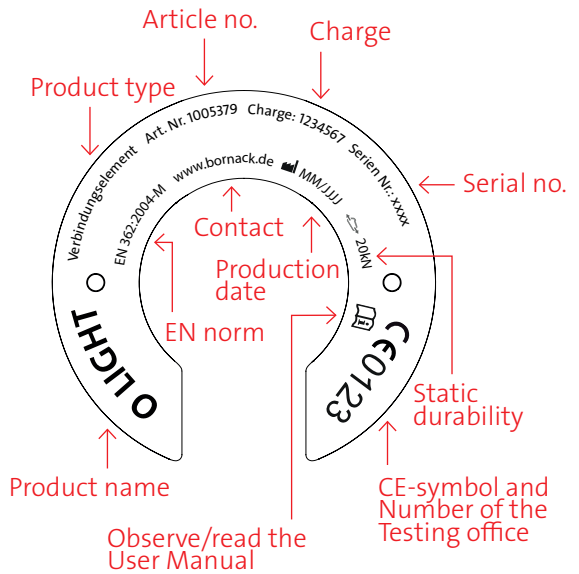

Packaging:

Manufacturer address →

BORNACK GmbH & Co. KG
Bustadt 39
74360 Ilsfeld

EU DECLARATION OF CONFORMITY



EU Declaration of Conformity

The manufacturer or his authorised representative established within the EU

BORNACK GmbH & Co. KG
Bustadt 39
74360 Ilsfeld
Germany

hereby declares that the following personal protective equipment

Connector EN 362-M
O LIGHT

- is in conformity with the relevant harmonisation legislation according to Annex V (Module B) of the Regulation (EU) 2016/425 on personal protective equipment according to Article 19 (category III PPE) and is examined to **EN 362:2004**
- is identical to the PPE that is the object of the **EU type-examination certificate No. PSA 040506 0270 Rev. 00**

issued by

TÜV SÜD Product Service GmbH
Zertifizierstelle
Ridlerstraße 65
80339 München
Germany
CE 0123

- is subject to the assessment of conformity to type, based on internal production control plus supervised product checks according to Module C2 of the Regulation (EU) 2016/425 for personal protective equipment (category III PPE), monitored by the notified body

TÜV SÜD Product Service GmbH
Zertifizierstelle
Ridlerstraße 65
80339 München
Germany
CE 0123

28 June 2019

BORNACK GmbH & Co. KG

Klaus Bornack
Managing Director

A handwritten signature in blue ink, appearing to read 'Klaus Bornack', written over the printed name and title.



TEST CARD

FOR ANNUAL MONITORING

The test list must be completed in full by the expert during the annual inspection.

This test list does not claim to cover all test criteria and does not relieve the expert from his decision about the overall condition.

Type product name: O LIGHT

Production date: _____

Charge no: _____ Serial no.: _____

Purchase date: _____

Date of first use: _____

Life span ends at the latest: _____

	Date	Signature	Next Inspection	Reason for inspection
1. year				
2. year				
3. year				
4. year				
5. year				
6. year				
7. year				
8. year				
9. year				
10. year				



Notes:

A series of 20 horizontal lines for taking notes.



FALLSTOP

Safety equipment for securing and rescuing at heights and depths

SAFEPOINT

Permanently installed safety systems for architects and industry

BORNACK GmbH & Co. KG

Bustadt 39
74360 Ilsfeld
Germany

Fon + 49 (0) 70 62 / 26 90 0-0
Fax + 49 (0) 70 62 / 26 90 0-550
info@bornack.de
www.bornack.de

© BORNACK – Subject to technical changes
Reprinting or duplication, even of excerpts, is only permitted with
written consent
Status: 07/2021 GAL Art.-Nr. 8000172_EN anh

